

Homemade Puzzles

The Trinket Box plans

This is a fairly simple puzzle to make, and not too hard to open. When opening, there are no parts that stick out, so it can be used as a little box for trinkets, or, gasp, cigarettes! Help your friends to stop smoking-give them one of these boxes.

This box was made from 1/8" and 1/4" plywood, and measures 4" x 2-1/2" x 2". You can of course, make this any size you wish, but you will have to re-size the dimensions.



From 1/4" plywood, cut these pieces:
 two at 4" x 1-1/2" (box front and back).
 two at 2-1/2" x 1-3/4" (box both ends).
 two at 4" x 1/2" (lid front and back).
 two at 2-1/2" x 1/2" (lid both ends).

From 1/8" plywood, cut these pieces:
 two at 4" x 2-1/2" (box bottom and lid top).
 one at 3-1/4" x 2" (lid inner panel).
 one at 1-1/2" x 1-1/2" (lid centre panel).
 two at 1-1/4" x 1-3/16" (lid side panels).
 The lock mechanism is also made from 1/8" ply: these parts are shown later.

Before assembling the box, shape the end pieces:

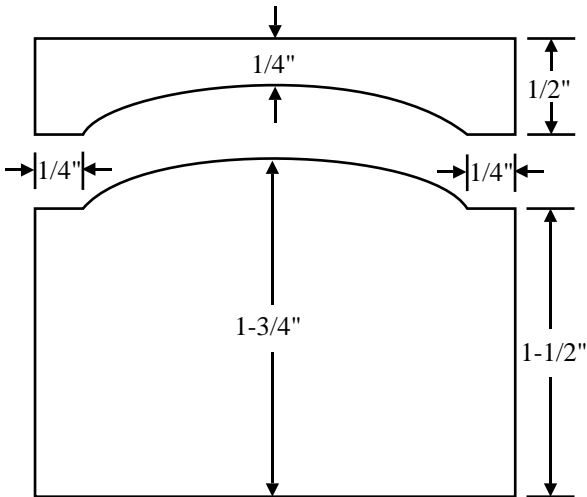

In making the box, I used three 1/2" finger joints for each corner of the box, and two 1/4" joints for the lid. You can glue the base on to the box at this time, but do not glue the top on. The assembled box and lid should look this:

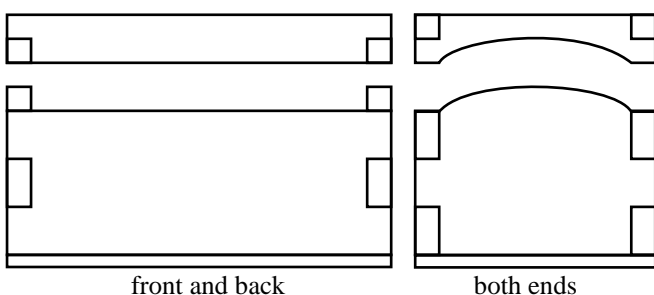

Cut these holes in the top panel:

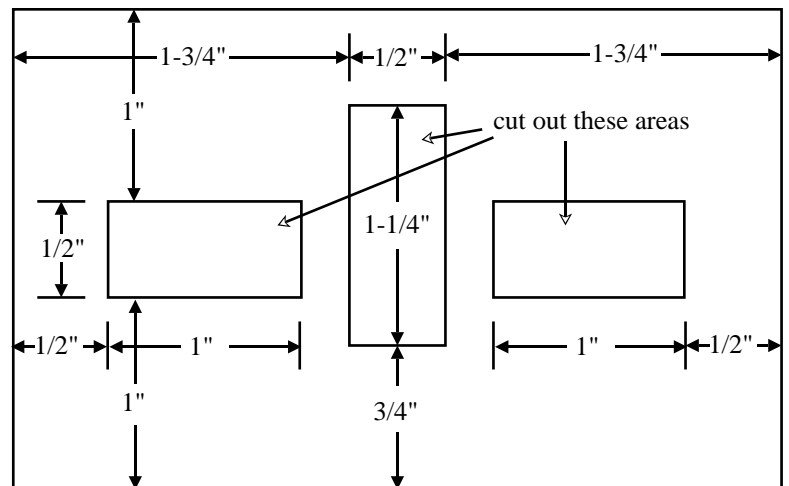

From 1/8" ply, cut the sliders:

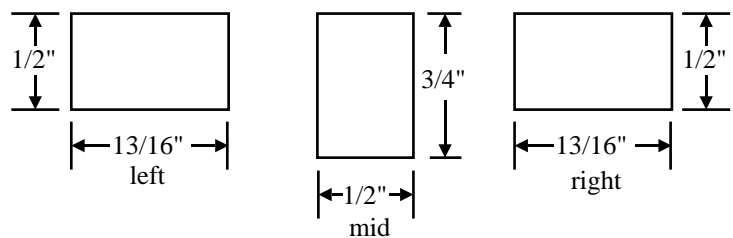

From 1/8" ply, cut the inner sliders:

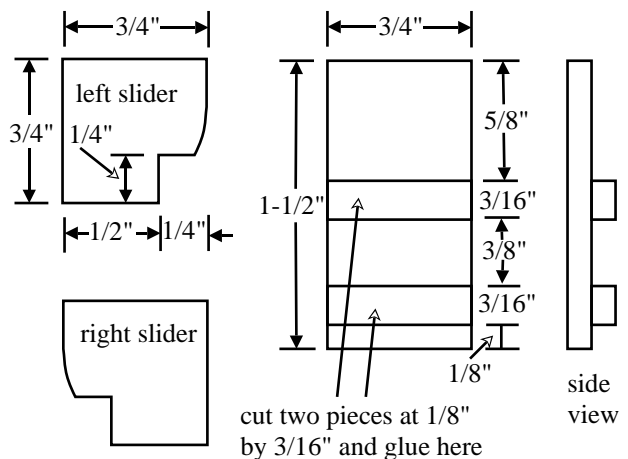

Cut the top panels to these shapes:

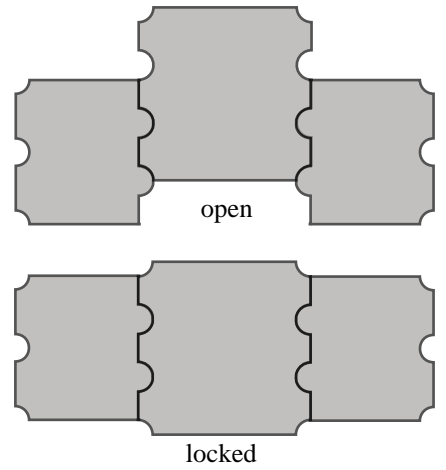
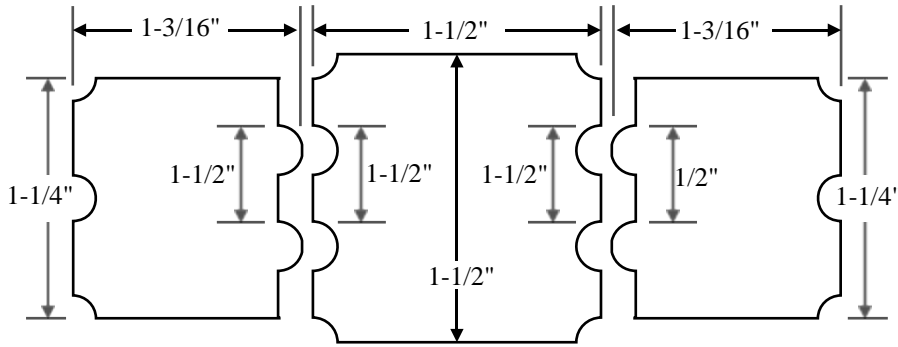

You don't have to follow this pattern, but you should note that the pattern is actually part of the locking mechanism. The two side panels fit into the edges of the middle panel, preventing it from moving. When the two panels are moved aside, the middle panel is free to move 1/2", and the side panels are moved back in order to open the lock, and must fit into the edges of the middle panel again. So any pattern you use must be repeated at 1/2".

Glue the lid frame onto the top panel. From 1/8" ply: cut two pieces at 1/8" by 1-1/4", and glue into place, as shown in the light shaded areas. Cut four pieces at 1/8" x 1/8" x 7/16" and glue onto the 1/8" strips as shown in the darker shaded areas. Notice the slight bevel on the lower pieces. These three pieces will hold the locking end of the latch. Also cut from 1/8" ply, two pieces at 1/4" x 5/8". Taper one end as shown, and glue into place at A and B. These will stop the latches from moving back in from the locking slots.

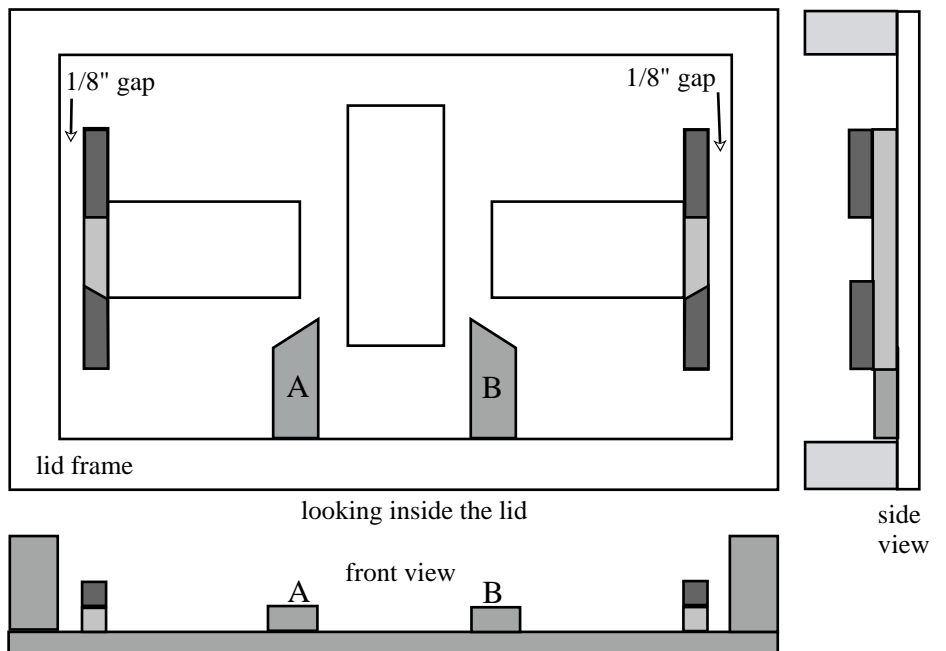

Position the top panels outside the lid, as shown in the lighter dotted areas, place the sliders in their holes, as shown in the darker areas, and glue together. Check that the two outer panels can move sideways 3/16", and the middle panel can move 1/2", and the side panels will fit back into the edges of the middle panel after it has moved. These side panels have to fit back into the middle panel in order to open the box lid.

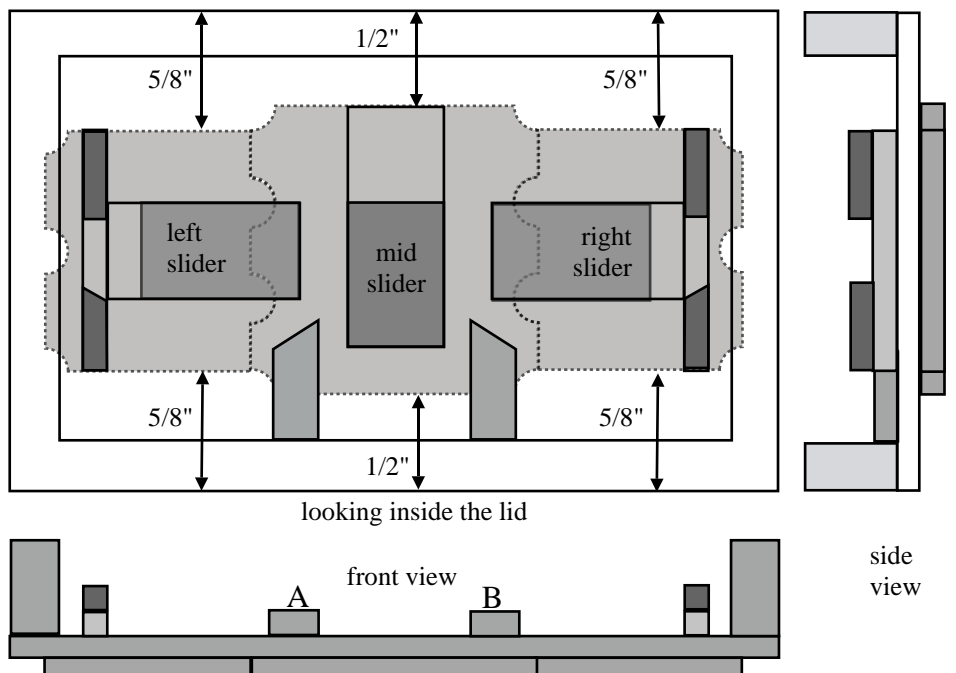

Position the inner sliders in place, as shown in the darker areas, and glue onto the sliders. Again, make sure that all the panels can move. From 1/4" or 3/8" square stripwood, cut four blocks just over 1/4" long. (I cut mine at 9/32"). Glue into place as shown at A,B,C and D. These will hold the inner lid panel in place, but allow the latches to move. When the lid is in place, the latches are upside down, and must not drop out of the inner sliders.

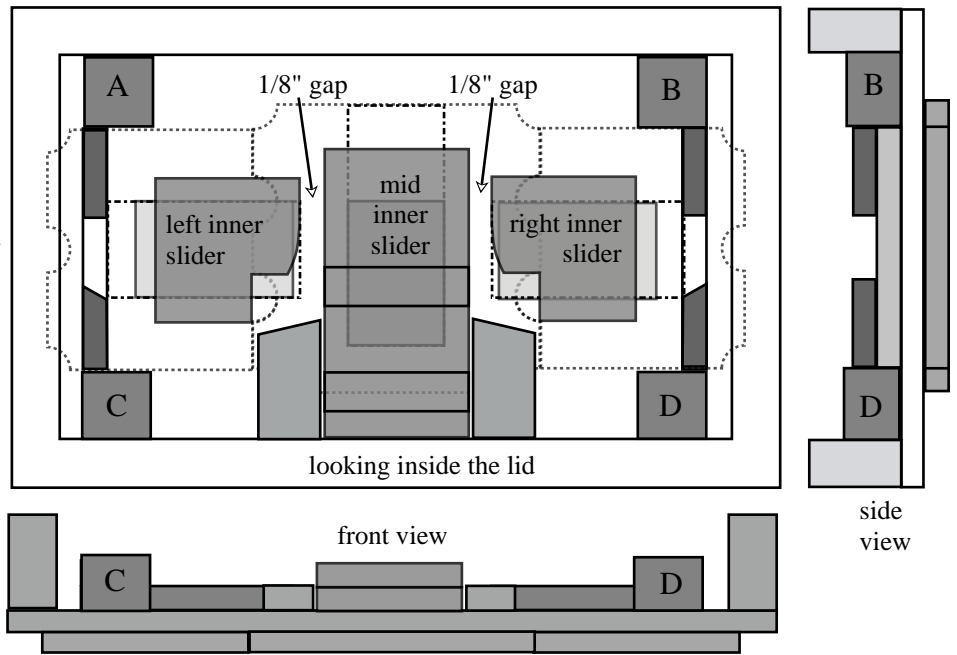

From 1/8" ply, cut two pieces at 1/4" x 1-5/8". These are the two latches. Note the bevel on the ends. Insert two pins into each latch, so that they protrude just under 1/8". These latches should fit onto the two inner sliders, and positioned so that the sliders can push the latches into the locking slot, and withdraw them again.

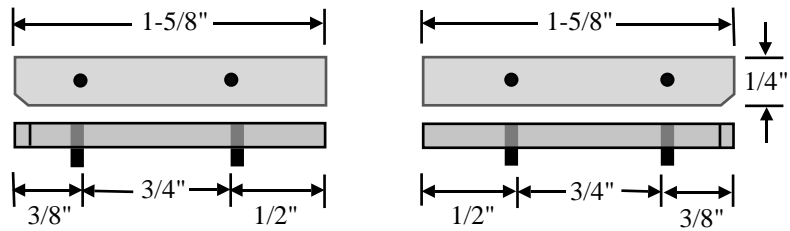

Move the left and right sliders outwards, and push the middle slider upwards. Place the latches onto the left and right sliders, as shown. When the sliders are moved back to the middle, the latches will move inwards, releasing the lid.

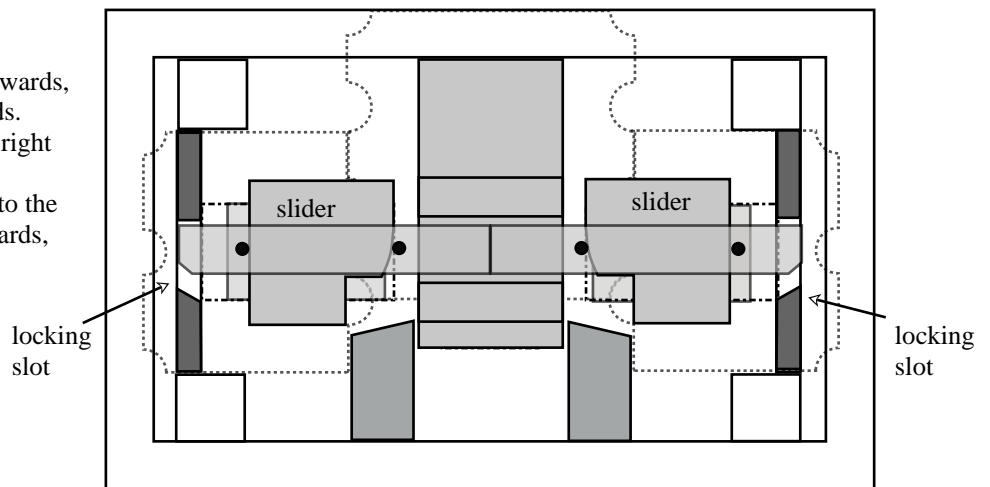

Now move the sliders back out, and push the middle slider downwards. This will push the inner ends of both latches downwards, causing the inner pins to move away from the slider ends. The latches will not move out of the locking slots, as the inner sliders still hold them in place.

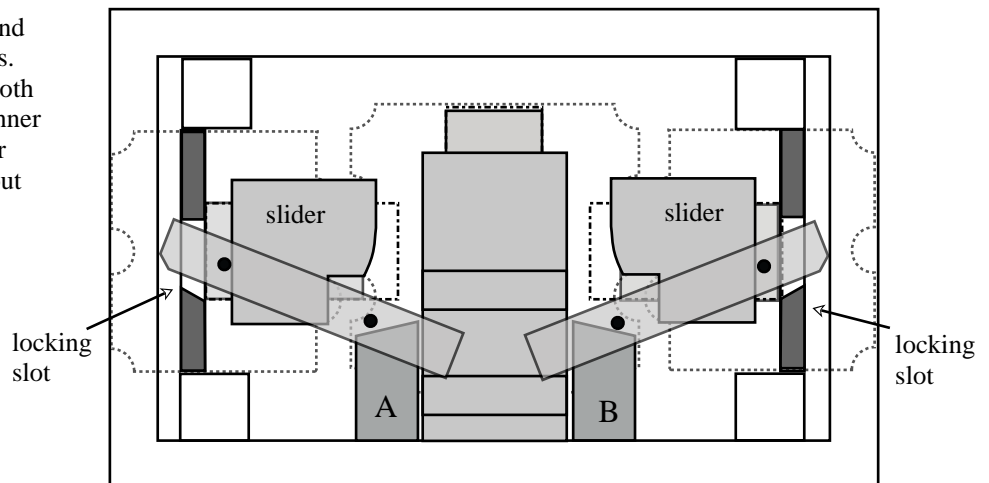

Moving the two side sliders back to the middle will not move the latches, and the lid will stay locked. Blocking pieces A and B will stop the latches from moving back in.

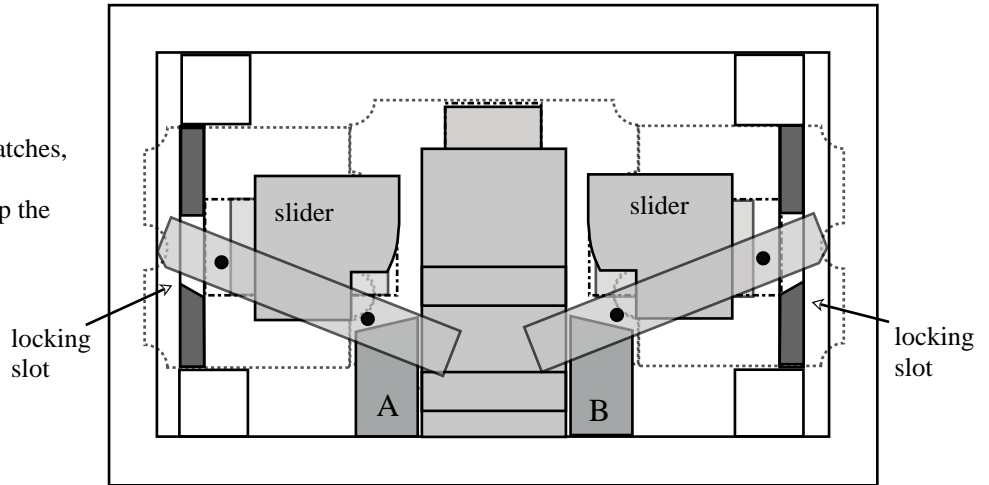

Hold the lid inner panel in place, and turn the lid rightside up. Check that everything still works. If it's all okay, glue the lid inner panel in place.

Before cutting the slot, drop the locking pieces into the box, and hold against the ends. Check to see where the latch will engage in the locking piece. This depends how much the latch drops when the lid is the right way up. After the slots are cut, glue the locking pieces to the inside of the box end pieces.

From 1/8" ply, cut two pieces to this shape:

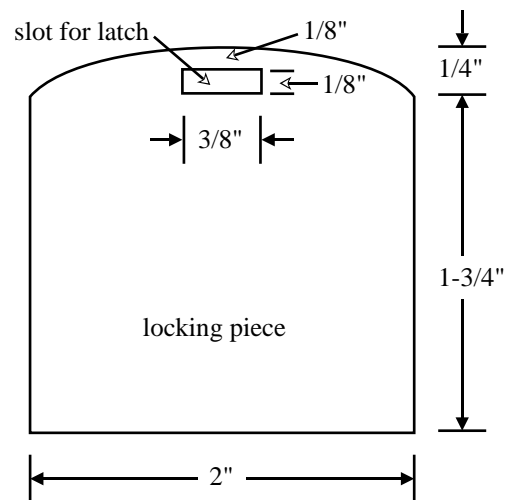

For the finish, I stained and varnished the box, and painted the top panels black, before gluing the top panels to the sliders. The inside was lined with green baize.

The lid and locking mechanism before the lid inner panel is glued into place.

Enjoy your puzzle!

These plans are free.
If you to sell or give away this puzzle, please mention where the plans came from.
© Bruce Viney. July, 2007

Get more plans and solutions at Homemade Puzzles.
Web address: www.homemadepuzzles.co.uk
E-mail: bruce@homemadepuzzles.co.uk